

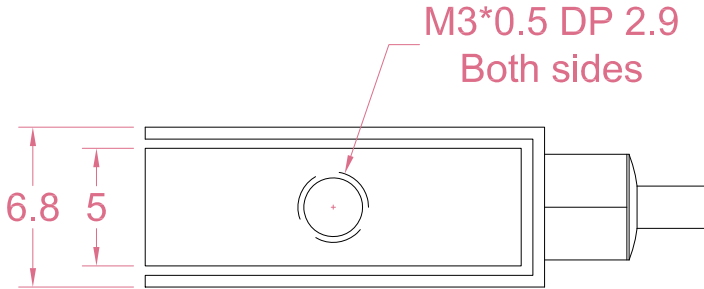

Dimensions in "mm"

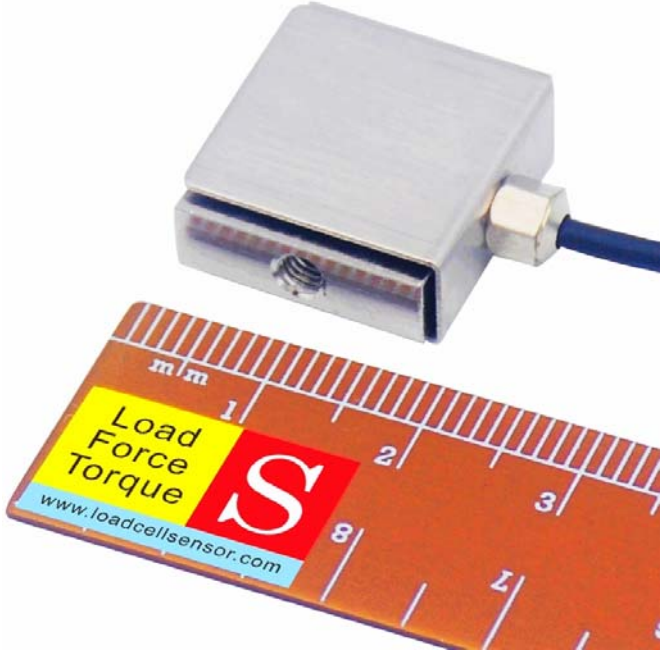
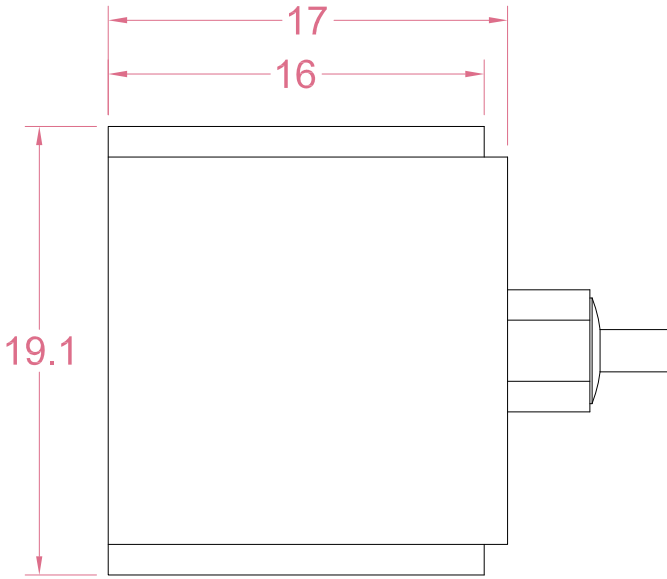

Order example:

2 x LCS02 - 10N

Quantity Model Capacity

Email to sales@loadcellsensor.com for a quote

Specifications			
Rated Capacity	10/20 N		
Rated Output	2.3 mV/V	Compensated Temp.	0...+40°C
Excitation	3~12V	Operating Temp.	-20...+60°C
Zero Balance	±0.1 mV/V	Temp. Coeff. of Zero	±0.02% F.S./°C
Nonlinearity	±0.1% F.S.	Temp. Coeff. of Span	±0.02% F.S./°C
Hysteresis	±0.1% F.S.	Input Resistance	380±30 Ohms
Nonrepeatability	±0.05% F.S.	Output Resistance	350±5 Ohms
Creep(5min)	±0.05% F.S.	Insulation Resistance	>2000M Ohms(50V)
Safe Load Limit	120% F.S.	IP Rating	IP50
Breaking Load	150% F.S.	Element Material	Stainless steel
Cable	Ø2*4000mm 4-conductor shielded cable		

• LCS reserves the right to modify its design and specifications without notice





Load direction

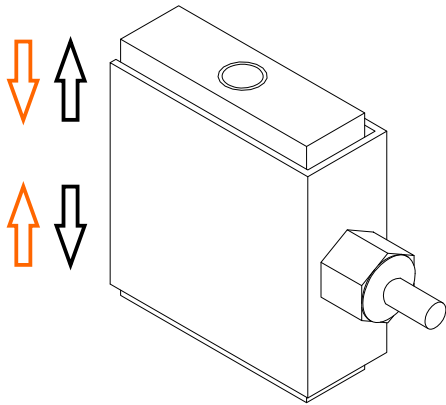

Wiring Code@Compression

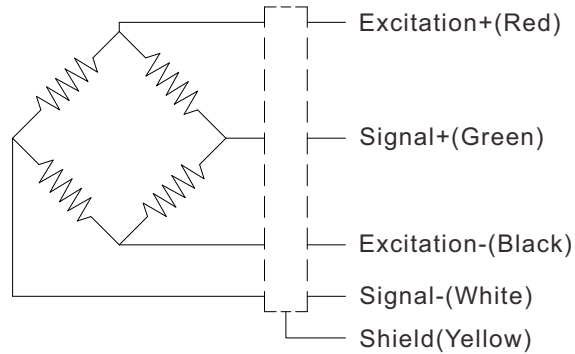

Shield is NOT connected to the sensor body

Precautions

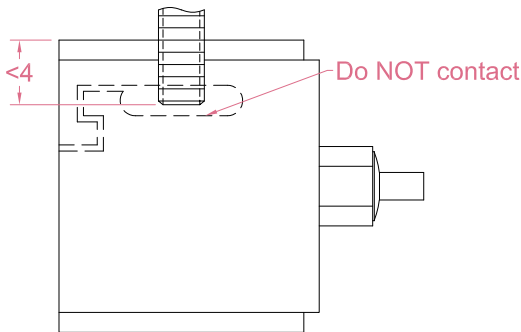

The mounting depth of the bolt is recommended to be less than 4mm to keep distance from the “Do NOT contact” surface. Same for both sides.

Sensor/Amplifier/Indicator

Items	Power supply	Output/Function
LCS02	3-12V (Constant)	-24mV...+24mV (Depending on the power supply)
LCS02 + Analog amplifier	12~24V DC	0-3.3V,0-5V,0-10V,0-2.5-5V,0-5-10V -3.3-3.3V,-5-5V,-10-10V 0-20mA,4-20mA,4-12-20mA...
LCS02 + Digital amplifier	12~24V DC	RS485 or RS232 output
LCS02 + Indicator	12~24V DC	Display force value Switch/Relay output Peak holding RS485/RS232 interface 0-5V/0-10V/4-20mA output

[Email us for datasheet of amplifier and indicator](mailto:sales@loadcellsensor.com)

